

| 構成内容 / Components | | | | |
|-------------------|--|--------------|--|------------------------------|
| No. | 名称 / Part name | 数量 / Pcs | 材質 / Material | 色・表面処理 / Color・Finish |
| 1 | 上下カバー Top and Bottom cover | 各1 1 each | アルミ板 A1100P t2.0 Aluminium A1100P t2.0 | シルバーアルマイト Silver・Anodized |
| 2 | Wパネル W panel | 2 | アルミ板 A1100P t2.0 Aluminium A1100P t2.0 | シルバーアルマイト Silver・Anodized |
| 3 | Dパネル D panel | 2 | アルミ板 A1100P t2.0 Aluminium A1100P t2.0 | シルバーアルマイト Silver・Anodized |
| 4 | 支柱 Extruded pillar | 4 | アルミ押出材 A6063S-T5 Extruded aluminium A6063S-T5 | シルバーアルマイト Silver・Anodized |
| 5 | 取付ビス (六角穴付皿M4 x 10) Screw (Hexagonal M4 - 10) | 8 | ステンレス Stainless steel | 無処理 Unfinished |
| 6 | ゴム足 / Rubber feet | 0 or 5 | ポリウレタン / Polyurethane | 透明 / Transparent |

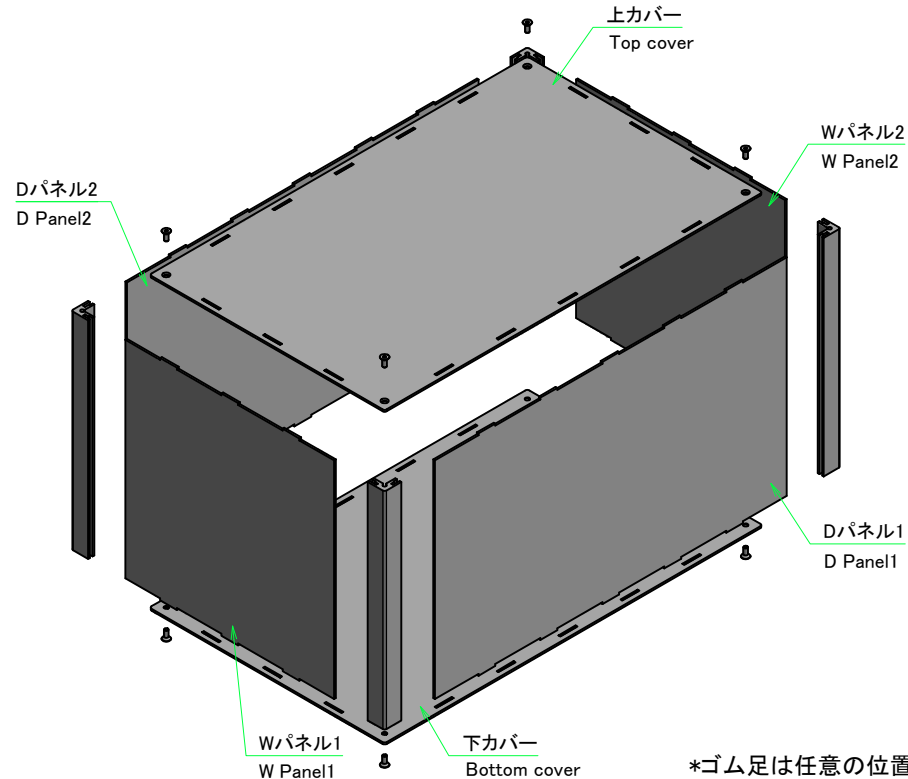

■六角レンチ付です。
Hexagonal wrench included.

ケース型番 / Product Number

ALSF W - H - D K20 タイプ Type ゴム足 Rubber feet

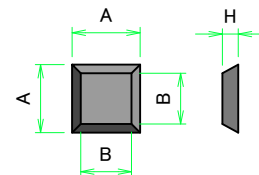

*ゴム足は任意の位置に貼り付けできます。
*Adhesive rubber feet in cluded

| ゴム足 / Rubber feet | | | |
|-------------------|------|------|-----|
| 記号 / Code | A | B | H |
| N (無し) / None | - | - | - |
| S | 12.7 | 9.5 | 3 |
| L | 20.6 | 12.7 | 7.6 |

| W・H・D 寸法制限範囲 / Dimension limit range | | |
|--------------------------------------|----------|-----------|
| W | H | D |
| 50 ~ 100 | 30 ~ 500 | 301 ~ 400 |

| | | | | |
|---|------------|------------|---|----------|
| 株式会社タカチ電機工業 TAKACHI ELECTRONICS ENCLOSURE CO., LTD. | | | 品名/Title 角型アルミフリーサイズケース CUSTOM SIZED ALUMINIUM CASE | 尺度/Scale |
| 承認/Approved | 検閲/Checked | 製図/Created | 型番/Product number ALSF□-□-□K20□ (W50~100, D301~400) | |
| 中根 | 常山 | 野村 | 作成日/Date 2021/01/06 | 1 / 5 |

外視 / External View

Wパネル2 / W Panel 2

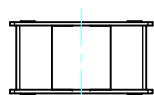

Dパネル2 / D Panel 2

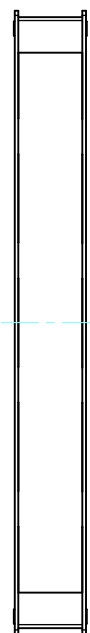

上カバー / Top cover

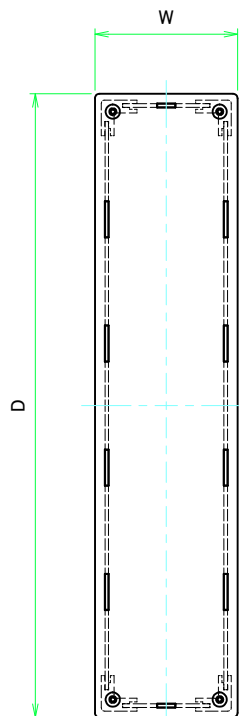

Dパネル1 / D Panel 1

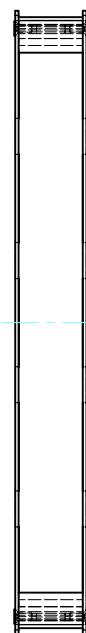

下カバー / Bottom cover

Wパネル間 有効寸法
Max dim. (between W panel) W-15.2

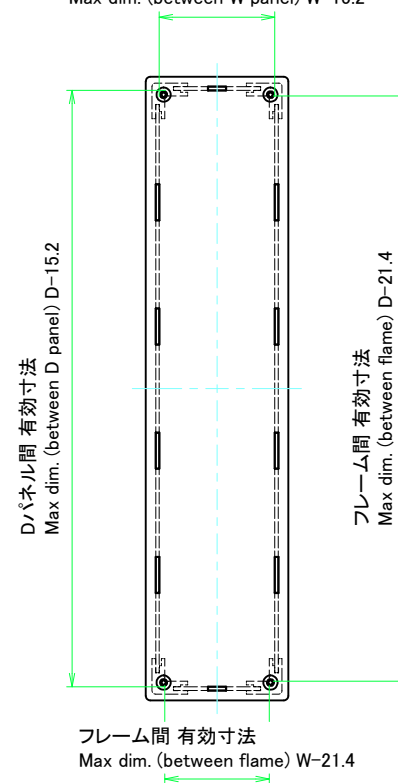

Dパネル間 有効寸法
Max dim. (between D panel) D-15.2

フレーム間 有効寸法
Max dim. (between frame) D-21.4

フレーム間 有効寸法
Max dim. (between frame) W-21.4

Wパネル1 / W Panel 1

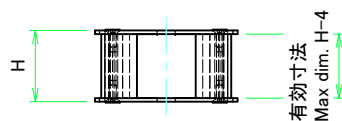

| | | | | |
|--|------------------|------------------|---|-----------------|
| 株式会社タカチ電機工業 <small>TAKACHI ELECTRONICS ENCLOSURE CO., LTD.</small> | | | 品名/Title 角型アルミフリーサイズケース CUSTOM SIZED ALUMINIUM CASE | 尺度/Scale 1:3 |
| 承認/Approved 中根 | 検図/Checked 常山 | 製図/Created 野村 | 型番/Product number ALSF□-□-□K20□ (W50~100, D301~400) | |
| | | | 作成日/Date 2021/01/06 | 2 / 5 |

上下カバー / Top and Bottom cover

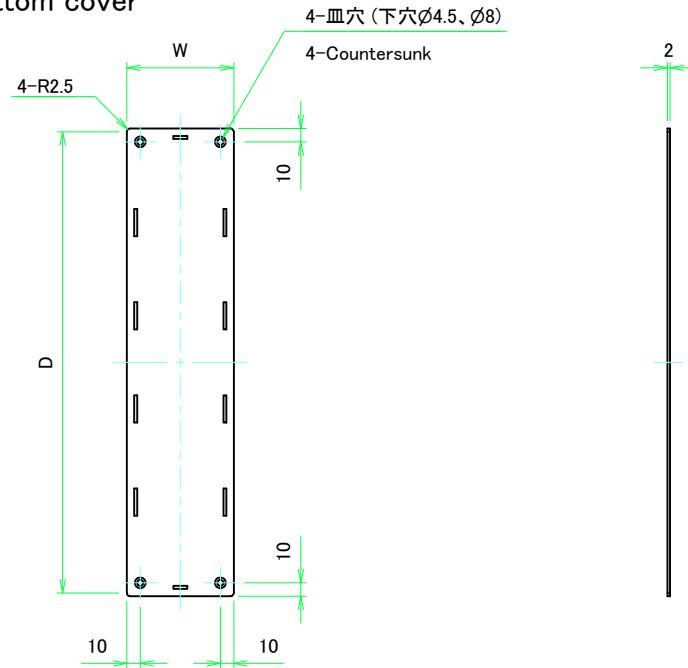

上カバー表面 / Top cover Frontside

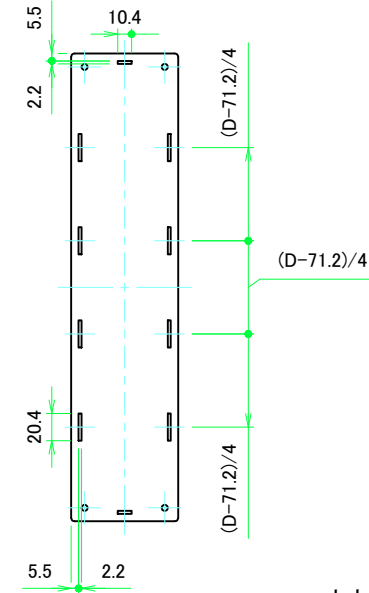

上カバー裏面 / Top cover Backside

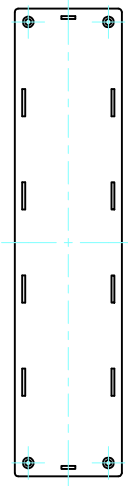

下カバー表面 / Bottom cover Frontside

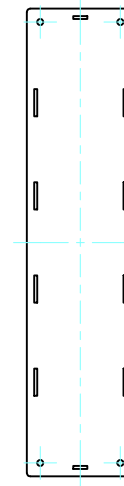

下カバー裏面 / Bottom cover Backside

| | | | | |
|--|------------|------------|---|-----------------|
| 株式会社タカチ電機工業 TAKACHI ELECTRONICS ENCLOSURE CO., LTD. | | | 品名/Title 角型アルミフリーサイズケース CUSTOM SIZED ALUMINIUM CASE | 尺度/Scale 1:4 |
| 承認/Approved | 検図/Checked | 製図/Created | 型番/Product number ALSF□-□-□K20□ (W50~100, D301~400) | |
| 中根 | 常山 | 野村 | 作成日/Date 2021/01/06 | 3 / 5 |

Wパネル / W Panel

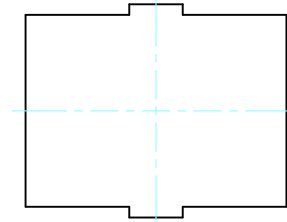
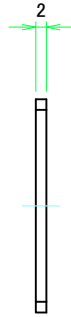
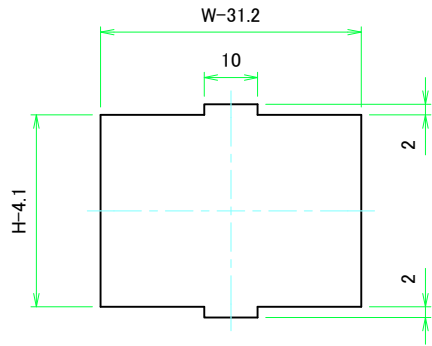

Wパネル1表面 / W Panel 1 Frontside

Wパネル1裏面 / W Panel 1 Backside

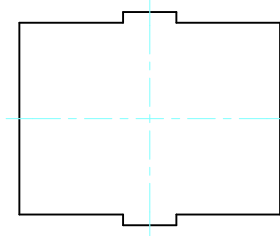
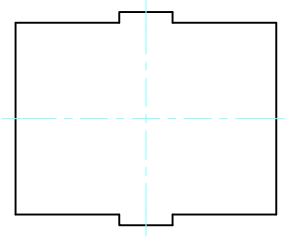

Wパネル2表面 / W Panel 2 Frontside

Wパネル2裏面 / W Panel 2 Backside

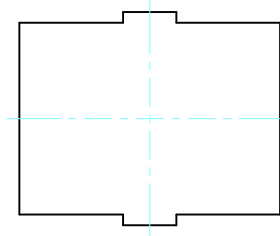
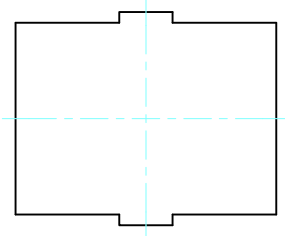

| | | | | |
|--|------------------|------------------|---|--|
|  株式会社タカチ電機工業 TAKACHI ELECTRONICS ENCLOSURE CO., LTD. | | | 品名/Title 角型アルミフリーサイズケース CUSTOM SIZED ALUMINIUM CASE |  尺度/Scale 1:1 |
| 承認/Approved 中根 | 検図/Checked 常山 | 製図/Created 野村 | 型番/Product number ALSF□-□-□K20□ (W50~100, D301~400) | |
| | | | 作成日/Date 2021/01/06 | 4 / 5 |

Dパネル / D Panel

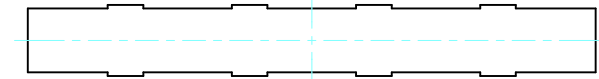
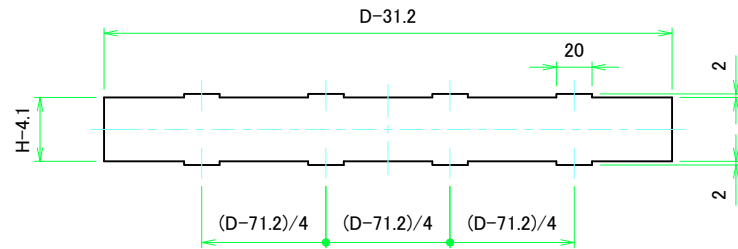

Dパネル1表面 / D Panel 1 Frontside

Dパネル1裏面 / D Panel 1 Backside



Dパネル2表面 / D Panel 2 Frontside

Dパネル2裏面 / D Panel 2 Backside



| | | | | |
|--|-------------------------|-------------------------|--|-----------------|
| 株式会社タカチ電機工業 <small>TAKACHI ELECTRONICS ENCLOSURE CO., LTD.</small> | | | 品名/Title 角型アルミフリーサイズケース CUSTOM SIZED ALUMINIUM CASE | 尺度/Scale 1:3 |
| 承認/Approved 中根 | 検図/Checked 常山 | 製図/Created 野村 | 型番/Product number ALSF□-□-□K20□ (W50~100, D301~400) | |
| | | | 作成日/Date 2021/01/06 | 5 / 5 |